

**Description**  
**Descripción**

Occasional table with central polyethylene base available in 5 different colors and in 3 distinct heights. Options for table tops include lacquered board, oak, Solid Surface, Technical Stone, Carrara marble, black marble bamboo, Compacto high pressure laminate (HPL), in 3 different shapes: square, elliptical and round with a distinct measurement for each shape. Optional gloss lacquer base finish.

Mesa auxiliar con base central de polietileno disponible en 5 colores diferentes. Disponible en 3 alturas. Sobres de tablero lacado, roble, Solid Surface, Technical Stone, mármol Carrara, mármol negro bambú y Compacto laminado de alta presión (HPL), en 3 formas diferentes, cuadrado, elíptico y redondo, con una medida para cada forma de sobre. Opción de base en acabado laca brillo.

**Wood finish**  
**Acabado madera**  
**Oak / Roble**

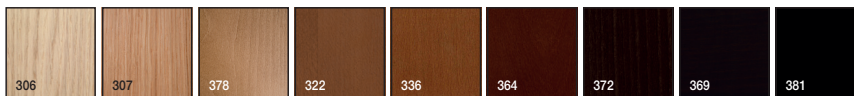

**Edge Perfil**  0.75

**Premium finish and wood lacquers**  
**Acabado premium y lacas madera**  
**Tops / Sobres**

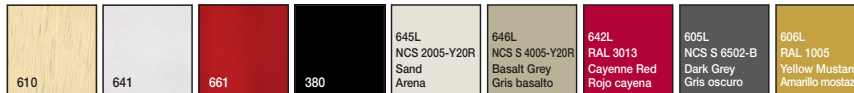

**Edge Perfil**  0.75

**Polyethylene finish**  
**Acabado de polietileno**

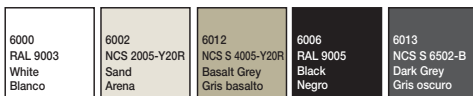

**Solid Surface finish**  
**Acabado Solid Surface**



**Edge Perfil**  0.50

**Compacto HPL**  
**Tops / Sobres**

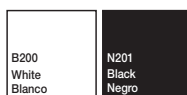

**Edge Perfil**  0.50

**Carrara marble finish**  
**Acabado mármol Carrara**



**Edge Perfil**  0.80

**Bamboo marble finish**  
**Acabado mármol bambú**



**Edge Perfil**  0.80

**Technical Stone finish**  
**Acabado Technical Stone**



**Edge Perfil** | 0.25

**Certificates**  
**Certificados**

Aluminum  
Aluminio

UNE CEN/TR 581-4 Durability of exterior-grade furniture.  
Durabilidad de mobiliario de exterior.

Compacto

EN 438-6, EN 4382-2-10, EN 4382-2-12, EN 4382-2-14, EN 4382-2-16, EN 4382-2-17, EN 4382-2-21, EN 4382-2-24, EN 4382-2-25, EN 4382-2-26, EN 4382-2-27, EN 4382-2-30, EN 12721.

European Standard:  
UNE EN 13501

**Custom finish up charge:**

Custom stain up charge \$ 240 NET.  
More than 10 items (Free custom color).

**Air freight packaging required, add \$80 net per table.**

 **Intellectual property / Propiedad intelectual**

All our collections are protected by international industrial design registries, designs patents, copyrights and Intellectual Property laws. Unauthorised use of AW International Property is a criminal offence and can lead to prosecution.

Todas nuestras colecciones están protegidas por registros de diseño industrial, diseño de patente, copyright y derechos de propiedad intelectual en todo el mundo. El uso no autorizado de los diseños y propiedad intelectual de AW supone un delito que puede ser sometido a acción judicial.



Reverse Occasional 45 / Reverse Occasional 55

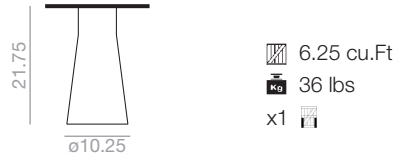
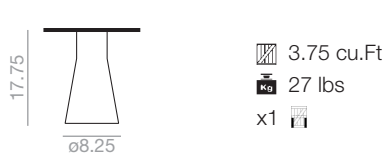

Column height Altura columna	Top measures Medidas sobre	Table top / Sobre													
		Lacquered Lacado		* Oak Roble		Solid Surface		Carrara marble Mármol Carrara		Bamboo marble Mármol bambú		Compacto HPL		Technical Stone	
		Ref.	\$	Ref.	\$	Ref.	\$	Ref.	\$	Ref.	\$	Ref.	\$	Ref.	\$
17.75	15.75x15.75	ME 5100	605	ME 5101	670	ME 5102	784	ME 5103	748	ME 5380	840	ME 5104	552	ME 5137	613
	ellipse/elipse 17.75x17.75	ME 5105	609	ME 5106	701	ME 5107	787	ME 5108	1,108	ME 5381	1,209	ME 5109	567	ME 5138	956
	ø17.75	ME 5110	619	ME 5111	708	ME 5112	799	ME 5113	1,108	ME 5382	1,202	ME 5114	571	ME 5139	956
21.75	19.75x19.75	ME 5115	677	ME 5116	770	ME 5117	1,096	ME 5118	961	ME 5383	1,111	ME 5119	644	ME 5140	667
	ellipse/elipse 21.75x21.75	ME 5120	682	ME 5121	792	ME 5122	1,177	ME 5123	1,351	ME 5384	1,491	ME 5124	679	ME 5141	1,047
	ø21.75	ME 5125	693	ME 5126	806	ME 5127	1,179	ME 5128	1,351	ME 5385	1,491	ME 5129	682	ME 5142	1,047

\*Up charge \$600.  
\*Incremento por \$600.

124

Column height Altura columna	Top measures Medidas sobre	Table top and base / Sobre y base			
		Marble finish Acabado mármol		Cement finish Acabado cemento	
		Ref.	\$	Ref.	\$
17.75	15.75x15.75	ME 5480	3,716	ME 5460	1,013
	ellipse/elipse 17.75x17.75	ME 5481	4,046	ME 5461	1,019
	ø17.75	ME 5482	4,046	ME 5462	1,025
21.75	19.75x19.75	ME 5483	5,456	ME 5463	1,089
	ellipse/elipse 21.75x21.75	ME 5484	5,804	ME 5464	1,101
	ø21.75	ME 5485	5,804	ME 5465	1,109

Up charge for bright  
lacquered finish base.  
Incremento por base laca  
brillo.

522

Power box / Sistema de conexiones

PS-0754



599

Optional preinstalled wiring / Preinstalación del cableado

IN-0007

Preinstalled wiring consists in the addition of the necessary mechanisms to integrate power systems in the table, so that wiring is hidden until the way out in the floor.

La preinstalación consiste en el montaje de los mecanismos necesarios para integrar el sistema de electrificación en la mesa, de modo que el cableado quede oculto hasta su salida por la base.

138

Reverse Occasional 35

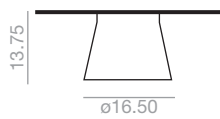

8-17.75 cu.Ft  
 80-234 lbs  
 x2

Column height Altura columna	Top measures Medidas sobre	Table top / Sobre													
		Lacquered Lacado		* Oak Roble		Solid Surface		Carrara marble Mármol Carrara		Bamboo marble Mármol bambú		Compacto HPL		Technical Stone	
		Ref.	\$	Ref.	\$	Ref.	\$	Ref.	\$	Ref.	\$	Ref.	\$	Ref.	\$
13.75	31.50x31.50	ME 5310	1,014	ME 5311	1,155	ME 5312	1,477	ME 5313	2,061	ME 5386	2,441	ME 5314	925	ME 5315	1,669
	35.50x35.50	ME 5331	1,139	ME 5332	1,385	ME 5333	1,509	ME 5334	2,186	ME 5387	2,703	ME 5335	1,024	ME 5336	1,739
	39.50x39.50	ME 5350	1,218	ME 5351	1,502			ME 5352	2,604	ME 5388	3,223	ME 5353	1,157	ME 5354	1,817
	43.25x43.25	ME 5366	1,341	ME 5367	1,591			ME 5368	2,939	ME 5389	3,674	ME 5369	1,392		
13.75	ellipse/elipse 35.50x35.50	ME 5317	1,129	ME 5318	1,383	ME 5319	1,509	ME 5320	2,636	ME 5390	3,135	ME 5321	1,012	ME 5322	1,793
	ellipse/elipse 39.50x39.50	ME 5338	1,200	ME 5339	1,499			ME 5340	2,944	ME 5391	3,545	ME 5341	1,151	ME 5342	1,863
	ellipse/elipse 43.25x43.25	ME 5356	1,327	ME 5357	1,587			ME 5358	3,279	ME 5392	3,997	ME 5359	1,383		
	ellipse/elipse 47.25x47.25	ME 5370	1,438	ME 5371	1,672			ME 5372	3,771	ME 5393	4,609	ME 5373	1,428		
13.75	ø35.50	ME 5324	1,129	ME 5325	1,383	ME 5326	1,509	ME 5327	2,636	ME 5394	3,135	ME 5328	1,012	ME 5329	1,891
	ø39.50	ME 5344	1,200	ME 5345	1,499			ME 5346	2,944	ME 5395	3,545	ME 5347	1,151	ME 5348	1,863
	ø43.25	ME 5361	1,327	ME 5362	1,587			ME 5363	3,279	ME 5396	3,997	ME 5364	1,383		
	ø47.25	ME 5374	1,437	ME 5375	1,664			ME 5376	3,771	ME 5397	4,609	ME 5377	1,432		

\*Up charge S600.  
 \*Incremento por S600.

274

Up charge for bright  
 lacquered finish base.  
 Incremento por base laca  
 brillo.

522

Reverse Occasional 35

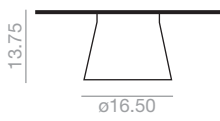

8-17.75 cu.Ft  
80-234 lbs  
x2

Column height Altura columna	Top measures Medidas sobre	Top & Base			
		Cement finish Acabado cemento		Marble finish Acabado mármol	
		Ref.	\$	Ref.	\$
13.75	31.50x31.50	ME 5466	1,680	ME 5630	7,088
	35.50x35.50	ME 5467	1,860	ME 5631	7,204
	39.50x39.50	ME 5468	1,989	ME 5632	7,598
	43.25x43.25	ME 5469	2,147	ME 5633	7,686
13.75	ellipse/elipse 35.50x35.50	ME 5470	1,854	ME 5634	7,623
	ellipse/elipse 39.50x39.50	ME 5471	1,956	ME 5635	7,912
	ellipse/elipse 43.25x43.25	ME 5472	2,135	ME 5636	8,235
	ellipse/elipse 47.25x47.25	ME 5473	2,300	ME 5637	8,697
13.75	ø35.50	ME 5474	1,854	ME 5638	7,623
	ø39.50	ME 5475	1,956	ME 5639	7,912
	ø43.25	ME 5476	2,135	ME 5640	8,235
	ø47.25	ME 5477	2,300	ME 5641	8,697

**UNDER-TOP POWER BOXES  
CAJA DE CONEXIONES BAJO EL SOBRE**

Power box mounted under the table top, available for any Reverse Occasional model.

Available in black color, for other finishing, contact the Customer Department. Data slot can be customized according to the below diagram:

Regleta de conexiones montada bajo la superficie del sobre disponible para cualquier modelo de mesa Reverse Occasional.

Se sirve en color negro, para otros acabados consultar al Departamento Comercial. Se ofrecen dos tamaños de caja diferentes y con conectividad configurable, acorde al siguiente esquema:

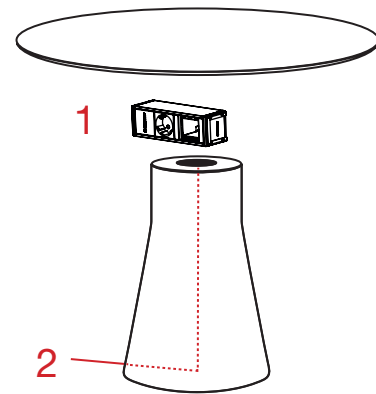

**PS-0754**

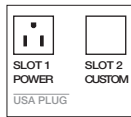

CHOOSE DATA PORT FOR DATA CUSTOM PORT SLOTS  
ELIJA UN CONECTOR DE DATOS PARA CADA PUERTO CONFIGURABLE

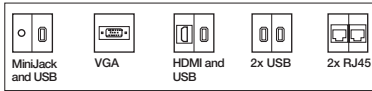

**1 POWER BOXES DISTRIBUTION / DISTRIBUCIÓN DE SISTEMAS**

By default, power system will be placed according to the image below .  
De serie el sistema se dispondrá en la posición que indica la siguiente imagen.

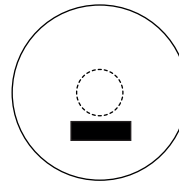

**2 CABLE WAY OUT / SALIDA DE CABLEADO**

The cable way out can be performed directly from the power system or thru a canal in the base bottom, so that is hidden until it gets to the floor.

La salida del cable se realiza directamente desde el propio sistema como por unas canalizaciones en la parte inferior de la base, de modo que el cable queda oculto hasta llegar al suelo.

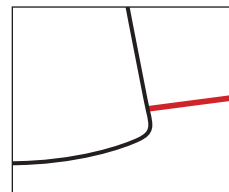

**OPTIONAL PREINSTALLED WIRING / PREINSTALACIÓN DEL CABLEADO**

**IN-0007**

Preinstalled wiring consists in the addition of the necessary mechanisms to integrate power systems in the table, so that wiring is hidden until the way out in the floor. Necessary grommet are included and 3m cable (from the power system). For other cable dimensions contact the Customer Department.

La preinstalación consiste en el montaje de los mecanismos necesarios para integrar el sistema de electrificación en la mesa., de modo que el cableado quede oculto hasta su salida por la base. Se incluyen los pasacables necesarios y 3 metros de cable (midiéndolo desde el sistema de conexiones).

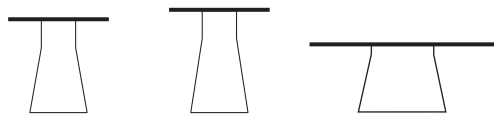

**Description**  
**Descripción**

Occasional table with central polyethylene base available in 5 different colors and in 3 distinct heights. Options for table tops include Technical Stone and Compacto high pressure laminate (HPL), in 3 different shapes: square, elliptical and round with a distinct measurement for each shape.

Mesa auxiliar con base central de polietileno disponible en 5 colores diferentes. Disponible en 3 alturas. Sobres de Technical Stone y Compacto laminado de alta presión (HPL), en 3 formas diferentes, cuadrado, elíptico y redondo, con una medida para cada forma de sobre.

**Polyethylene finish**  
**Acabado de polietileno**

6000 RAL 9003 White Blanco	6002 NCS 2005-Y20R Sand Arena	6012 NCS S 4005-Y20R Basalt Grey Gris basalto	6006 RAL 9005 Black Negro	6013 NCS S 6502-B Dark Grey Gris oscuro
-------------------------------------	--	--	------------------------------------	--

**Compacto HPL**  
**Tops / Sobres**

E200 White Blanco	N201 Black Negro	<b>Edge Perfil</b>  0.50
-------------------------	------------------------	--

**Technical Stone finish**  
**Acabado Technical Stone**

Earth brown Marrón tierra	Sand grey Gris arena	Stone grey Gris piedra	<b>Edge Perfil</b>  0.25
------------------------------	-------------------------	---------------------------	--

**Certificates**  
**Certificados**

Compacto HPL	European Standard: UNE EN 13501	EN 438-6, EN 4382-2-10, EN 4382-2-12, EN 4382-2-14, EN 4382-2-16, EN 4382-2-17, EN 4382-2-21, EN 4382-2-24, EN 4382-2-25, EN 4382-2-26, EN 4382-2-27, EN 4382-2-30, EN 12721.
Technical Stone	European Standard: UNE EN 13501-1:2	International Standards UNE EN ISO 10545-3, UNE EN ISO 10545-4, UNE EN ISO 10545-6, UNE ENV 12633, UNE EN ISO 10545-12, UNE EN ISO 10545-9.

**Intellectual property / Propiedad intelectual**

All our collections are protected by international industrial design registries, designs patents, copyrights and Intellectual Property laws. Unauthorised use of AW International Property is a criminal offence and can lead to prosecution.

Todas nuestras colecciones están protegidas por registros de diseño industrial, diseño de patente, copyright y derechos de propiedad intelectual en todo el mundo. El uso no autorizado de los diseños y propiedad intelectual de AW supone un delito que puede ser sometido a acción judicial.



Reverse Occasional 45 / Reverse Occasional 55

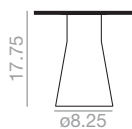

3.75 cu.Ft  
27 lbs  
x1



6.25 cu.Ft  
36 lbs  
x1

Column height Altura columna	Top measures Medidas sobre	Table top/Sobre			
		Compacto HPL		Technical Stone	
		Ref.	\$	Ref.	\$
17.75	15.75x15.75	ME 5104	552	ME 5137	613
	ellipse 17.75x17.75	ME 5109	567	ME 5138	956
	ø17.75	ME 5114	571	ME 5139	956
21.75	19.75x19.75	ME 5119	644	ME 5140	667
	ellipse 21.75x21.75	ME 5124	679	ME 5141	1,047
	ø21.75	ME 5129	682	ME 5142	1,047

Reverse Occasional 35

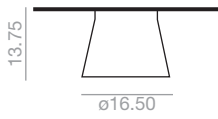

8-12.5 cu.Ft  
84-95 lbs  
x1

Column height Altura columna	Top measures Medidas sobre	Table top/Sobre			
		Compacto HPL		Technical Stone	
		Ref.	\$	Ref.	\$
13.75	31.50x31.50	ME 5314	925	ME 5315	1,669
	35.50x35.50	ME 5335	1,024	ME 5336	1,739
	39.50x39.50	ME 5353	1,157	ME 5354	1,817
	43.25x43.25	ME 5369	1,392		
13.75	ellipse 35.50x35.50	ME 5321	1,012	ME 5322	1,793
	ellipse 39.50x39.50	ME 5341	1,151	ME 5342	1,863
	ellipse 43.25x43.25	ME 5359	1,383		
	ellipse 47.25x47.25	ME 5373	1,428		
13.75	ø35.50	ME 5328	1,012	ME 5329	1,891
	ø39.50	ME 5347	1,151	ME 5348	1,863
	ø43.25	ME 5364	1,383		
	ø47.25	ME 5377	1,432		